



www.johnsonhardware.com

# INSTRUCTIONS

For 4-9/16" Walls  
Fits up to 3'0" x 6'8" Doors

## 1510/1511 Series Pocket Door Frame Jamb Kit

1. Install Pocket Door Frame following instructions as normal, including drywalling around opening. Carefully measure height "A" (from floor to bottom of frame header). Cut 1 1/16" x 4 9/16" Strike Jamb to this length.

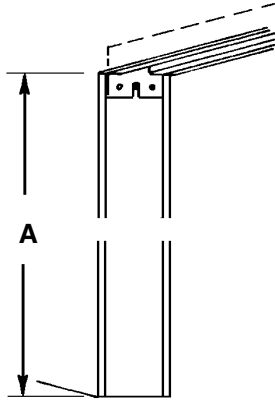

4. Carefully cut split headers to "C". Determine side of hangers with lock arm and fasten this header with screws for easy removal. Nail other side. Here, too, maintain 3/16" on each side of door.

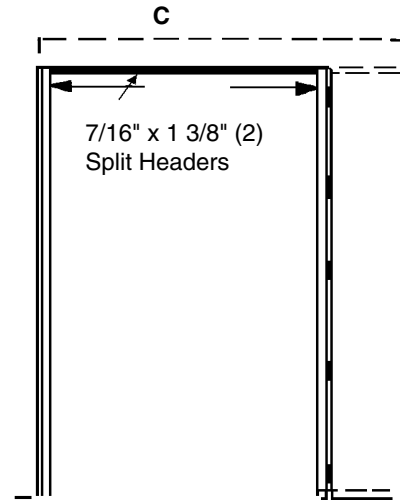
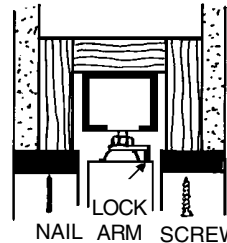

2. Open door fully (door will protrude into opening) and cut split jambs to "B". Fasten to front edge of frame. Maintain minimum 3/16" clearance on both sides of door. Raise or lower hangers to plumb door with split jambs.

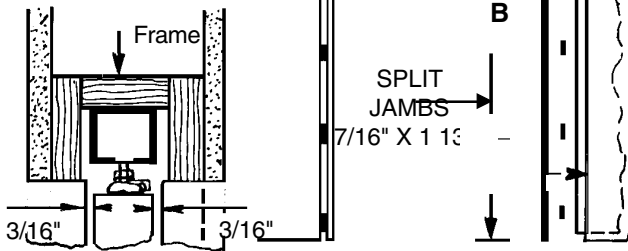

5. Fasten bottom door guides so that door stays in center of pocket, yet travels easily without binding.

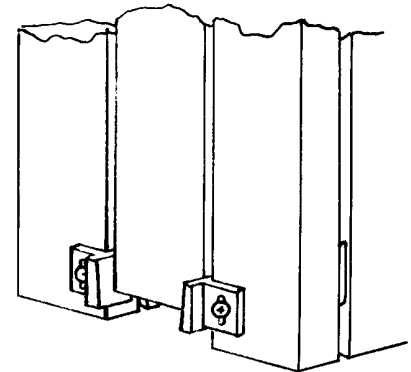

3. Shim and plumb strike jamb (wide piece) with door.

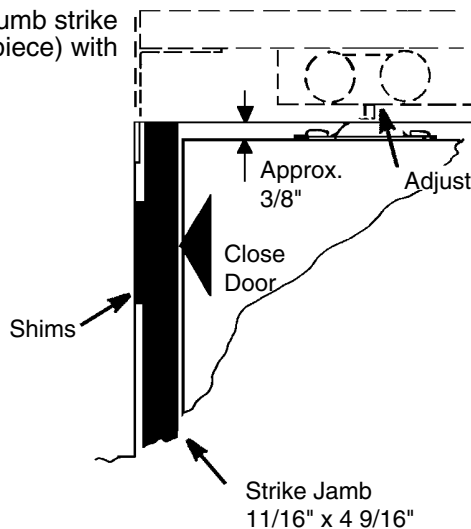

6. Finish with your choice of casings (not included).

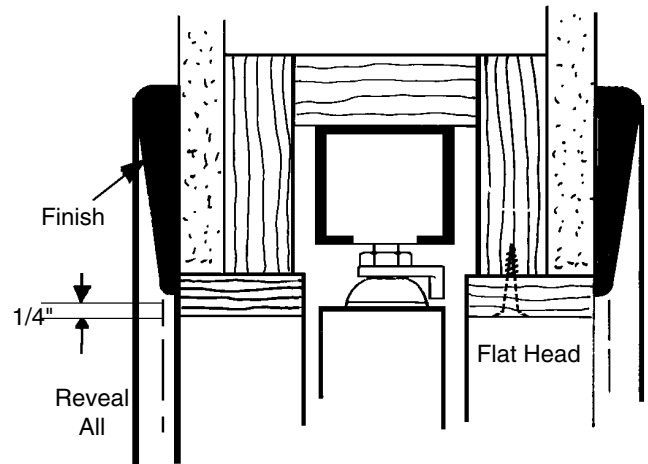

## GENERAL DESCRIPTION

A fast, convenient method of finishing Pocket Door Frames. Just cut to length and install – no ripping of special thickness stock. Pre-sanded so finishing is a snap. (Since a wide variety of casings are available, they are not included.)

Fits all makes of Pocket Door Frames designed for standard 4 9/16" walls using 3'0"(max) x 6'8" doors.

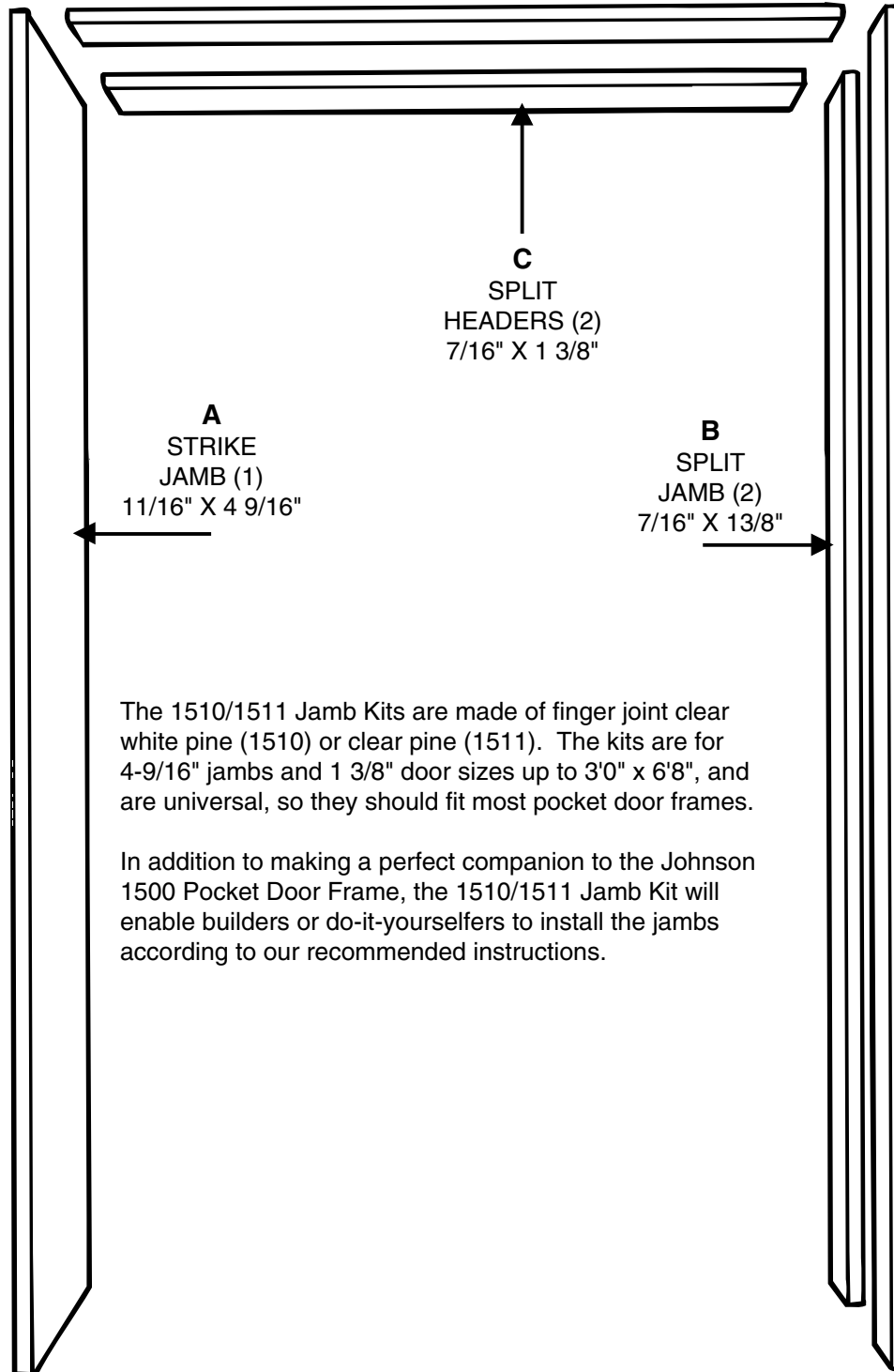

The 1510/1511 Jamb Kits are made of finger joint clear white pine (1510) or clear pine (1511). The kits are for 4-9/16" jambs and 1 3/8" door sizes up to 3'0" x 6'8", and are universal, so they should fit most pocket door frames.

In addition to making a perfect companion to the Johnson 1500 Pocket Door Frame, the 1510/1511 Jamb Kit will enable builders or do-it-yourselfers to install the jambs according to our recommended instructions.

