

FITTING INSTRUCTIONS - NOTICE DE POSE - MONTAGE HANDLEIDING - MONTAGEANLEITUNG INSTRUZIONI DI MONTAGGIO - INSTUCCIONES DE MONTAJE

Low Headroom installation kit used to reduce the clearance between the track and door to a minimum of 2mm.
Please note the door thickness must be between 34mm and 50mm.

Tools required

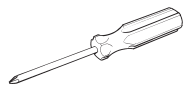

1 x Phillips screwdriver

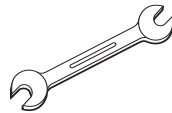

1 x Small Spanner (supplied)

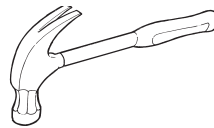

1 x Hammer

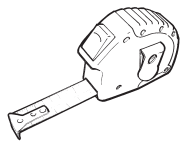

1 x Tape measure

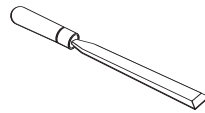

1 x Chisel

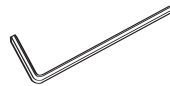

1 x Allen Key - 4mm (supplied)

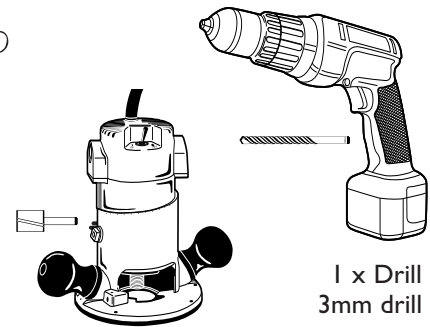

1 x Router + Ø26mm or less router bit

1 x Drill + 3mm drill bit

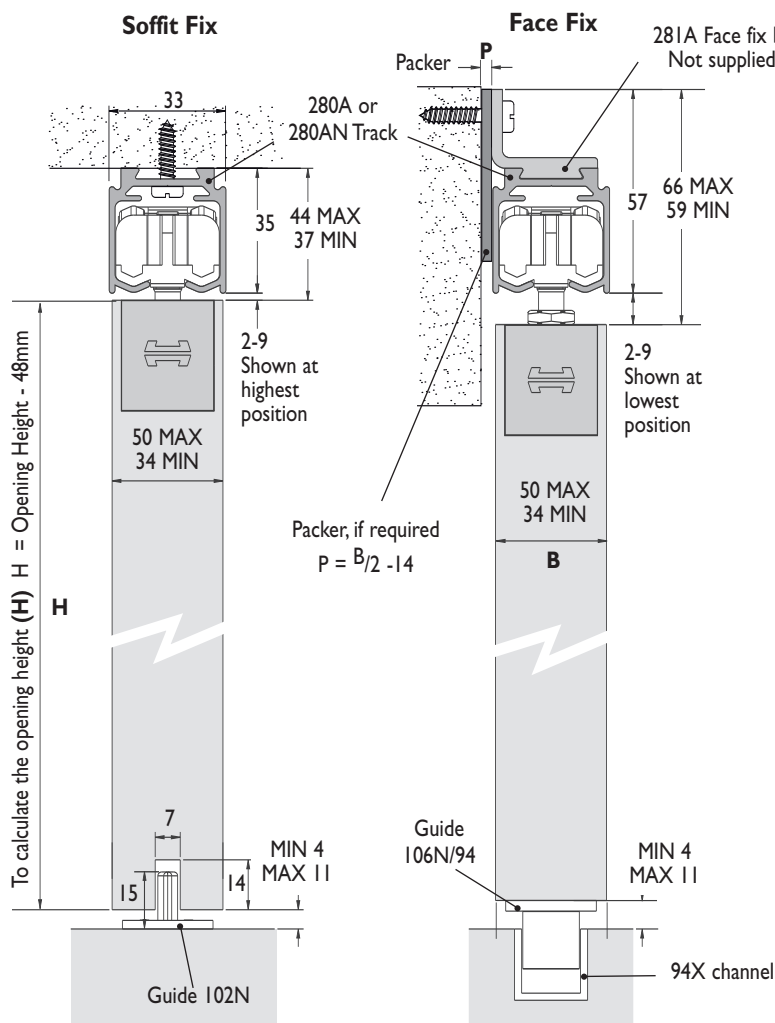

Parts Include

- 2 Low Headroom units
- 2 End caps
- 2 Low Headroom clip stops
- 1 Screw pack
- 2 Low Headroom hangers
- 1 Guide (102N)
- 1 Small Spanner
- 1 4mm Allen Key

*Aluminium Husky track (available in anodised or mill finish) and face fixing brackets are not included in the installation kit and must be ordered separately.

Alternative Guide Arrangement

Requires an additional 102N guide.
Not supplied in kit.

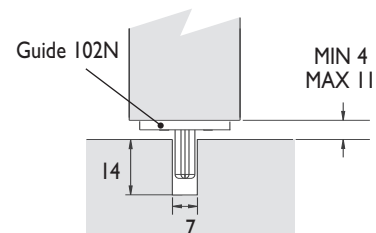

Alternative Guide Arrangement
Not supplied in kit.

All dimensions are in mm.

1 Place nut inside the hanger body. Thread the locking nut onto the bolt and then screw the bolt into the nut within the hanger. Leave a 13mm clearance between the base of the hanger and strap bolt head, as shown

2 Insert hangers and retaining stops at both ends of the track. Ensure hangers are inserted with their connecting end facing the end stops as shown. Then wind the nut to its highest position

3 Secure track to supporting structure

4 Face and Soffit fix options

5 Rout top of door as shown at both ends for channel bodies

6 Rout bottom of door for 102N guide (if required)

7 Fit door guide to floor

8 Fix both channel bodies into door with screws provided

9 Ensure the slider is in the highest position, lift the door into place onto hanger strap bolts and tighten lock nuts down

10 Adjust door height to reduce the clearance between the track and door

11 Fit end caps