

Architectural Door Accessories

ASSA ABLOY

Pemko Side Wall Track (SWT) System

The global leader in door opening solutions

Door Leaf Capacity - Up to 200 lbs.

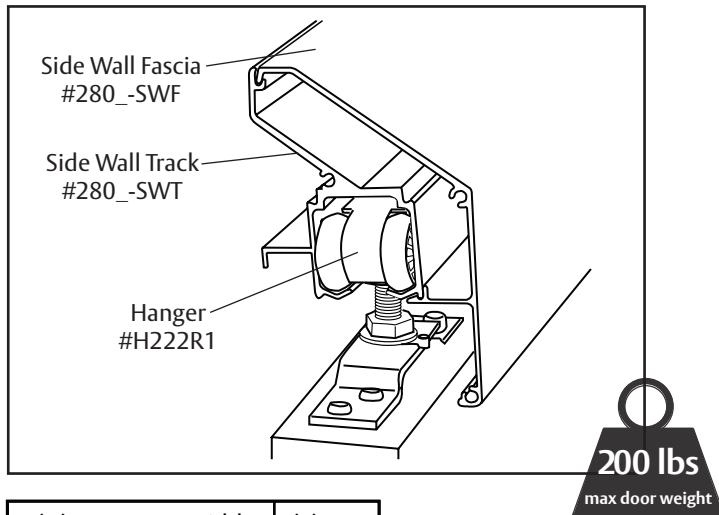

(A) Max. Door Width	(L) Run
30"	60"
36"	72"
48"	96"
2 @ 36"	144"

Kit No.	Material	Max Leaf Width
280C-SWTKIT/5	mill finished track / 5'	30"
280C-SWTKIT/6	mill finished track / 6'	36"
280C-SWTKIT/8	mill finished track / 8'	48"
280C-SWTKIT/12*	mill finished track / 12'	2 @ 36"
280D-SWTKIT/5	dark bronze track / 5'	30"
280D-SWTKIT/6	dark bronze track / 6'	36"
280D-SWTKIT/8	dark bronze track / 8'	48"
280D-SWTKIT/12*	dark bronze track / 12'	2 @ 36"

*NOTE: 280-SWTKIT/12 comes with enough hardware for two doors.

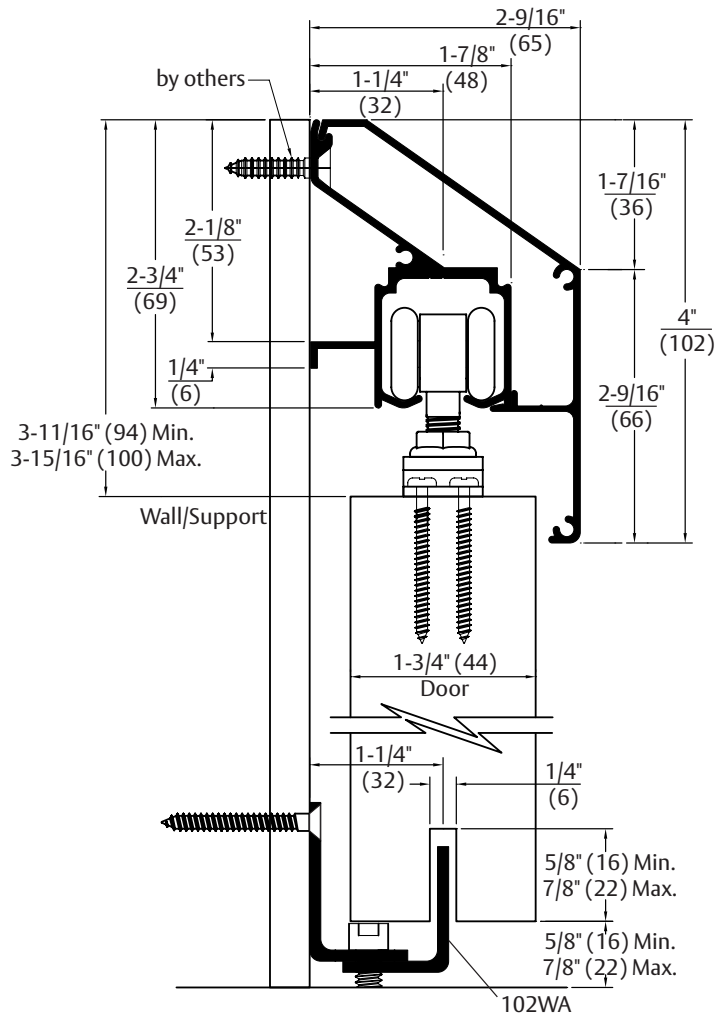

1. Assemble hangers.

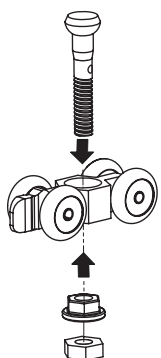

2. Fit hanger aprons to door panels.

Drill $\frac{1}{2}$ " (13) dia x $1\frac{1}{2}$ " (38) deep hole 5" (127) from door edge to centerline and centered in the door thickness.

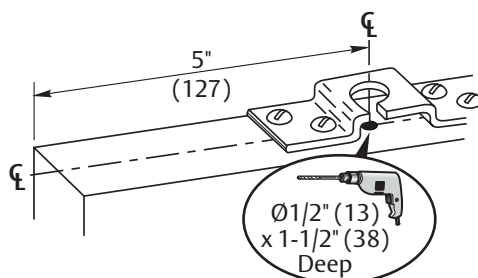

3. Insert hangers and retaining stops.

Ensure that hanger flange is pointing in the direction of clip portion of stop as shown below.

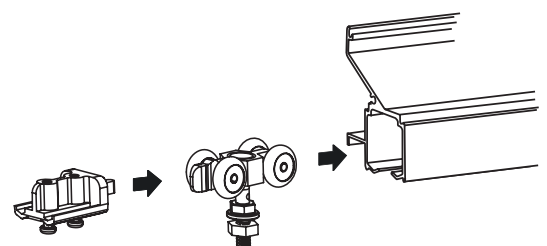

4. Secure track.

Locate mounting holes only in areas where wall offers sufficient backing to hold screw.

Check that track is level before finalizing mounting process.

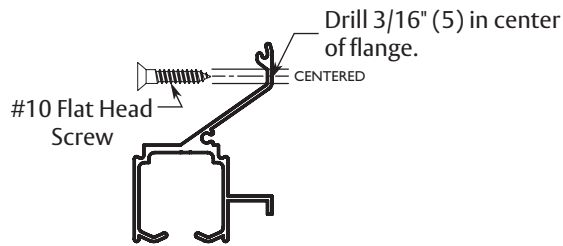

5. Mortise door.

If using floor mounted hanger, attach a plumb line to hanger. Place hanger inside track. Using plumb line, mark for position of door guide on the floor.

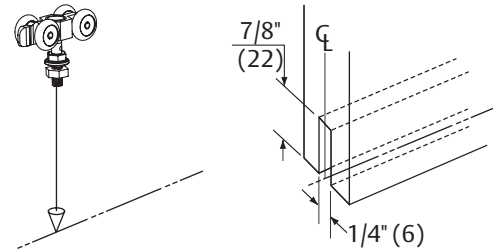

6. Fit either door guide 102N or 102WA.

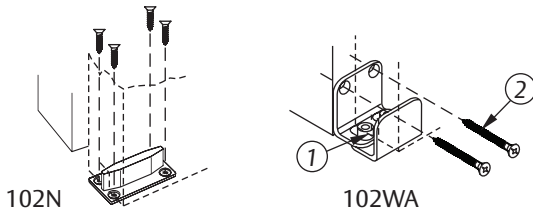

7. Attach door panel and adjust until level.

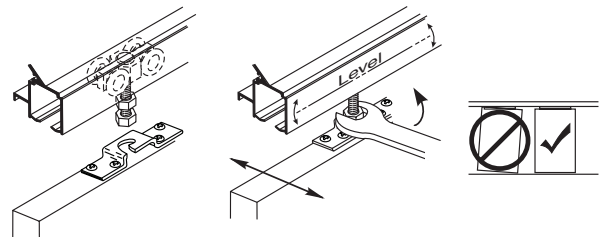

8. Position and secure retaining stop.

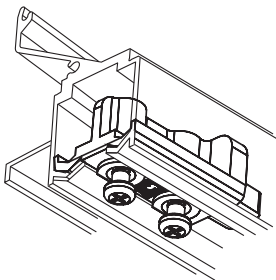

9. Snap on side wall fascia.

Insert point A of fascia into groove B on track. B should sit in the elbow of A; not beyond the tip. See detail. Then apply pressure at point C on fascia, beginning at one end and along the length of the track until it snaps into place.

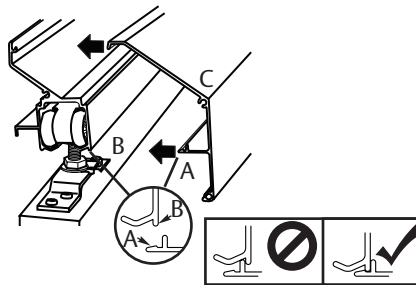

10. Install end plate.

